

# BOXY DISPENSER INSTALLATION GUIDE

REFILLABLE / 430ML e 14.5 FL OZ

BOTTLE SIZE (WITH PUMP): 65 L 65 W 175 H (mm)



TRIPLE BRACKET CONFIGURATION SIZE: 203 L x 85 W x 206 H (mm)



MATERIAL: HDPE Bottle & Stainless Steel Bracket



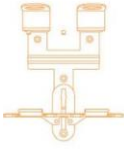
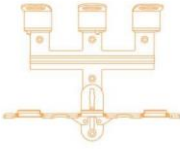
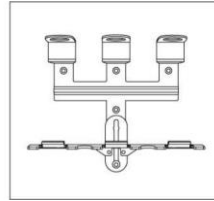
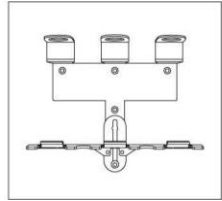

INFO: Tamper-Resistant Bracket & Fluid Indicator Window

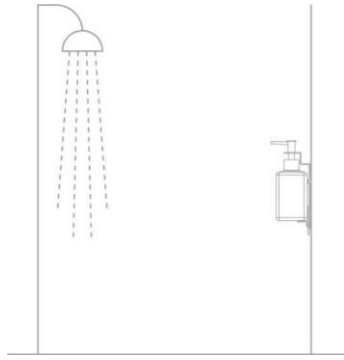

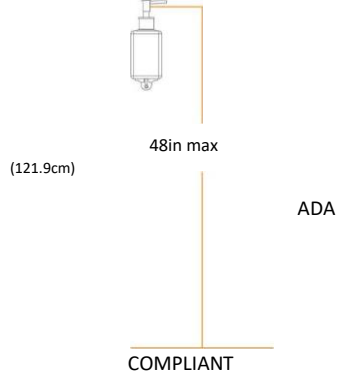
# BOXY DISPENSER INSTALLATION GUIDE

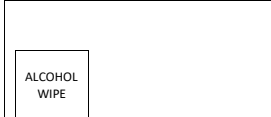
<b>PARTS INCLUDED IN INSTALLATION KIT</b> (SHAMPOO, CONDITIONER, AND BODY WASH ARE NOT INCLUDED)		 <p style="text-align: center;">(1) DOUBLE</p>	 <p style="text-align: center;">(1) TRIPLE</p>	 <p style="text-align: center;">BRACKET A</p>	 <p style="text-align: center;">BRACKET B</p>	
PLUGS (Ø 8MM) SCREWS (40x3MM PHILLIPS)			2x 3x 4x	Bracket type may vary depending on order.		
SINGLE BRACKET (1) DOUBLE BRACKET TRIPLE BRACKET (1) SINGLE						

<b>RECOMMENDED PLACEMENT GUIDE</b> ON THE BACK WALL, OPPOSITE OF THE SHOWER HEAD (NOT TO SCALE)	
 <p style="text-align: center;">CENTERED ON BACK WALL</p>	
 <p style="text-align: right;">ADA COMPLIANT</p>	

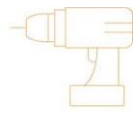
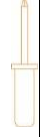
<b>RECOMMENDED TOOLS</b>	 <p style="text-align: center;">ALCOHOL WIPE</p>	 <p style="text-align: center;">LEVEL</p>	 <p style="text-align: center;">TAPE MEASURE</p>	 <p style="text-align: center;">3MM HEX KEY</p>	 <p style="text-align: center;">DOUBLE SIDED TAPE</p>	 <p style="text-align: center;">POWER DRILL</p>	 <p style="text-align: center;">SCREW DRIVER</p>
--------------------------	---	--	---	---	--	--	---

<b>CLEANING INFO</b>	(This section is currently blank in the provided image)
----------------------	---

# BOXY DISPENSER INSTALLATION GUIDE

When bottles become warm water and mild  
To deep clean the bottle and remove any the bottle, wash clean, until you have a  
Avoid using acid,  
Disclaimer: Hotel Emporium

empty, wash thoroughly with warm water and soap. Air dry completely before refilling with liquids. Between uses, clean with soap using a soft and damp cloth or brush. Dry with a soft cloth.

bottles and bracket, remove bottles first and clean items separately. To clean inside the bottle, gently remove from the residue. Pump warm water through the pump and straw to flush out any remaining liquid. Dump any remaining product from then air dry the bottle completely. Refill bottle with matching liquid and tighten pump and / back into place. Push pump continuous flow of liquid.

osive, or aggressive cleaning products which can damage the product surface finish.

is not responsible for contamination of bacteria growth in dispensers due to infrequent and/or improper cleaning.



Clean wall surface with alcohol wipe.  
Make sure surface is fully dry before  
installation.

# BOXY DISPENSER INSTALLATION GUIDE

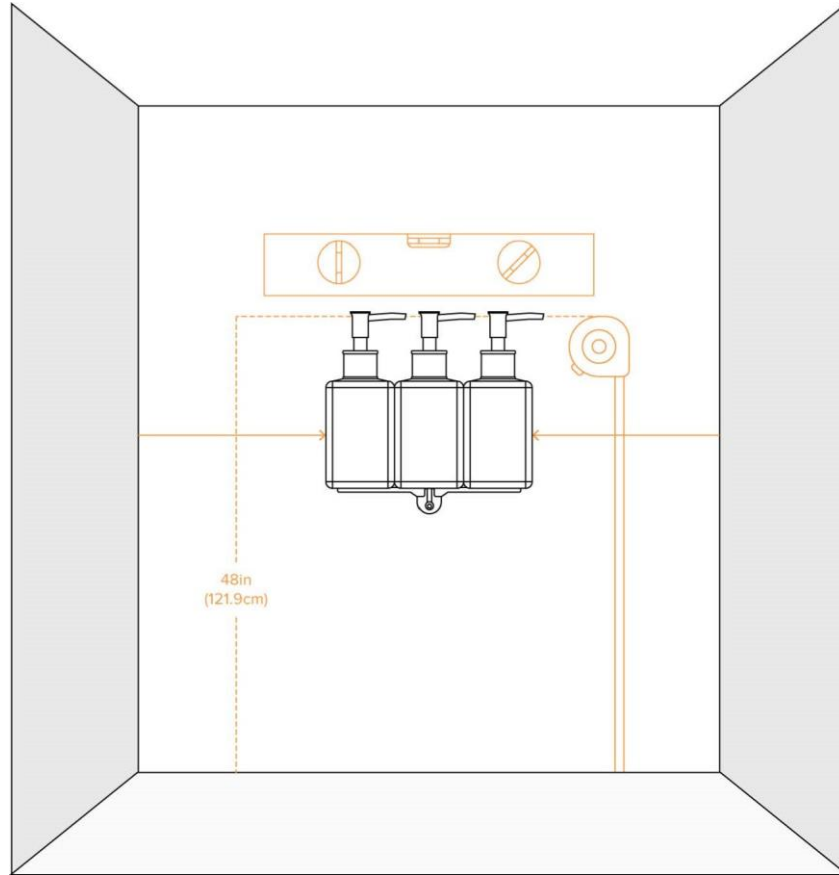

Determine the proper placement of dispenser by using the brackets as guides and determine what type of installation is needed. Screws and adhesive in combination is recommended. Mark the bracket placement and make sure it is level. Recommended height is 48" from the floor to the pump of the dispensers.

--	--

## BOXY DISPENSER INSTALLATION GUIDE

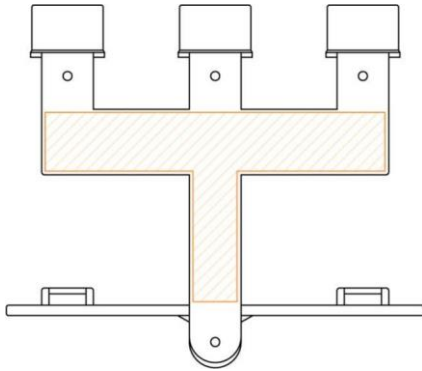

### Tape Installation

1. Wipe bracket clean and dry before applying
2. tape. Remove the protection strips of the tape on one side and stick it on the back side surface of the upper bracket part.

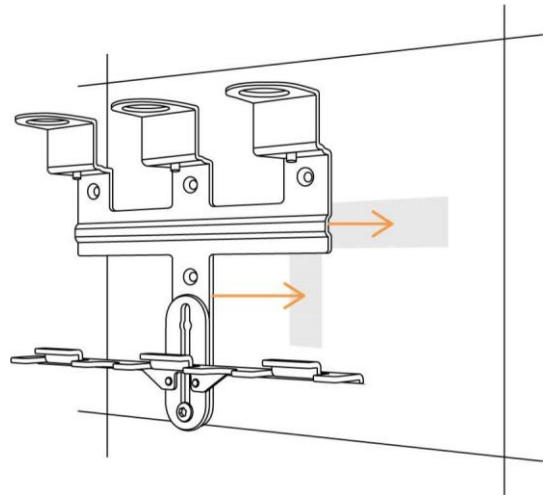

Remove the protection strip from the other side of the tape and stick the bracket on the wall. Let the tape cure for a 72 hours before further installation of the dispensing bottles and the lower bracket assembly.

## BOXY DISPENSER INSTALLATION GUIDE

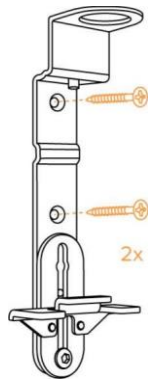

Single

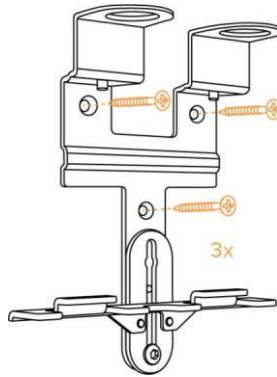

Double

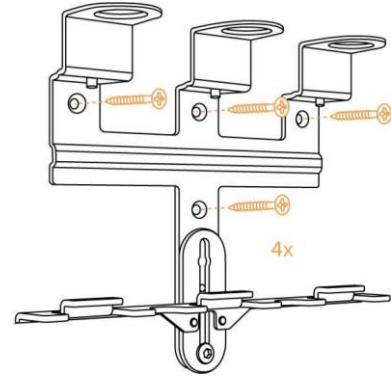

Triple

### Screw Installation

1. Drill holes in the wall corresponding with the bracket holes and place the wall plugs in these holes. For drilling, we recommend to use drill size 8 (8mm), corresponding with the plugs included.
2. Fix the upper bracket by mounting the screws in the corresponding wall plugs. Refer to the image for the correct placement of the screws for a reliable and stable installation (per bracket version).

# BOXY DISPENSER INSTALLATION

## GUIDE

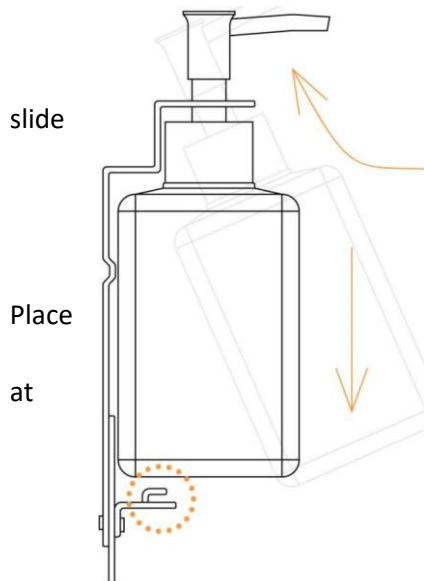

Using a hex key, slightly loosen the bottom screw of the lower bracket counter clockwise (half circle) and the bracket downwards.

Position the bottle(s) by directing the dispenser cap through the holes of the upper bracket.

Place the bottle(s) on the lower bracket and making sure it fits into the indentation at the bottom of the bottle.

## BOXY DISPENSER INSTALLATION

### GUIDE

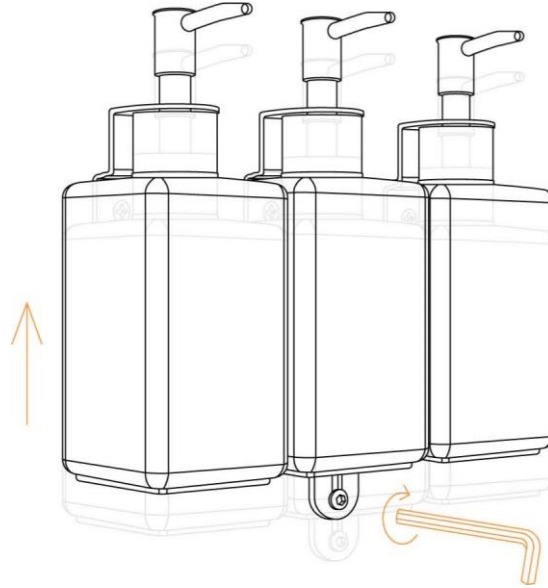

Slide the lower bracket including the bottle(s) upwards until the bottles are firmly clamped between the lower and upper bracket part. Make sure the metal pin on the upper bracket fits into the indentation at the top of the bottle. Once positioned correctly, tighten the screw of the lower bracket by turning clockwise. Dispenser is now ready to use!

To change and replace the bottles, Step 4-5 will be repeated each time the bottles are empty.